

grazia&co melbourne  
1 / 10-14 advantage road  
highett, vic, 3190  
phone +61 3 9555 5760

grazia&co sydney  
12b, 32 ralph street  
alexandria, nsw, 2015  
phone +61 2 8914 0350

## harvey relaxed sofa



made in australia, the harvey relaxed is a fully upholstered sofa with straight arm detail and extended relaxed side and back cushions. side, seat and back cushions are made with australian fr commercial foam and wrapped in a feather / fibre casing. straight leg or curved tube metal base powder coated as specified.

grazia&co<sup>®</sup>

## house leather

semi aniline leather  
origin: italy



5484  
burgundy



3394  
taupe



3338  
navy



3360  
green



3328  
caramel



5478  
tan



2208  
light grey



black

## boucle

composition: 28% acrylic / 24% cotton / 20% viscose / 16% wool / 12% polyester  
origin: netherlands  
martindale cycles: 80,000



00  
cream



27  
terracotta



55  
deep green



88  
charcoal

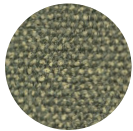

56  
green melange



73  
chocolate  
melange

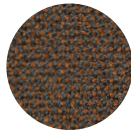

82  
orange melange

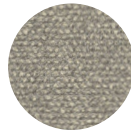

89  
grey melange

## velvet

composition: 39% cotton / 28% alpaca / 11% polyester / 9% wool / 7% nylon / 6% viscose.  
origin: italy  
martindale cycles: 100,000



burnt orange



ochre

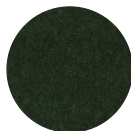

ivy

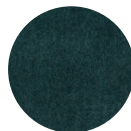

deep teal



pinot noir



ebony



blush



midnight

## twine

composition: 82% acrylic / 18% polyester  
origin: turkey  
martindale cycles: 100,000

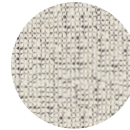

granite

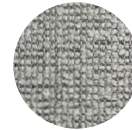

grey marl



linen



riverstone

## linen weave

composition: 15% linen / 40% cotton / 20% viscose / 20% acrylic / 5% polyester  
origin: belgium  
martindale cycles: 45,000

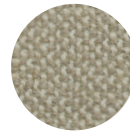

putty

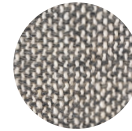

granite

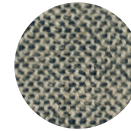

indigo

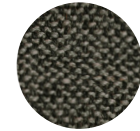

onyx

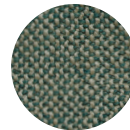

teal

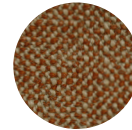

rust

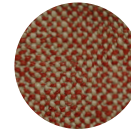

carmine

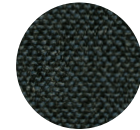

lapis

## powder coat

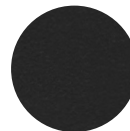

texture black



texture white

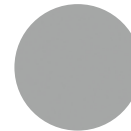

apo grey



texture suede

custom finishes as specified

grazia&co<sup>®</sup>

# technical specifications

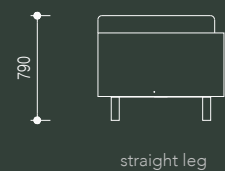
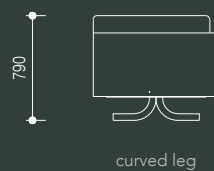
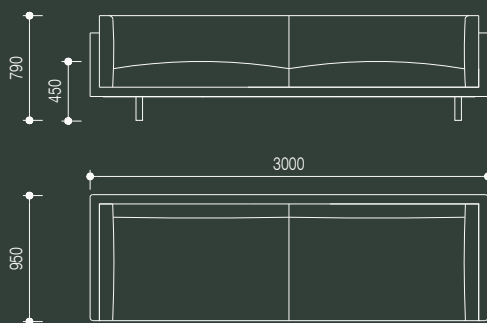
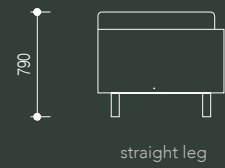
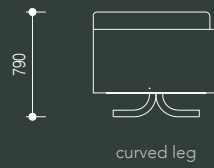
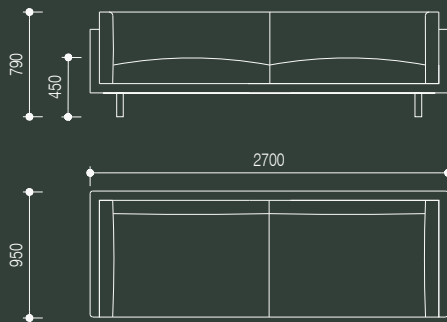
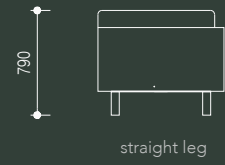
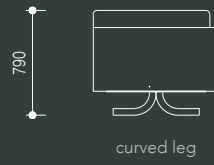
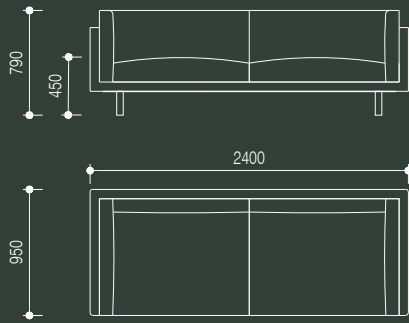

year released  
2021

## warranty

- i. warranty period of 7 years for the structural integrity of the furniture under 'normal use'
- ii. the warranty covers the timber and metal frames, the suspension and the foam integrity.
- iii. fabric and leather wear and tear are not warranted.
- iv. fabric and leather that has faded or broken down due to exposure to sunlight or extreme weather conditions is not warranted.
- v. care instructions and warranty claims of fabric to be addressed with the textile supplier or specifier.
- vi. it is the responsibility of the specifier and/or supplier that has selected and/or supplied a fabric or leather through 3rd party suppliers to ensure it is free of faults and fit for purpose and application.

all terms outlined in this document are applicable exclusively to projects and orders that are based in australia.

for warranty claims outside australia, please note that a 12 month warranty period will apply, all claims are to be taken up with the international selling agent

to view the full warranty please refer to the link below  
<https://graziaandco.com.au/grazia-terms-and-conditions/>

<b>craftmanship:</b>	manufactured in australia
<b>materials:</b>	fully upholstered ply frame, feather wrapped foam and specified upholstery
<b>lead time:</b>	8-10 weeks. lead times may vary during peak periods
<b>suitability:</b>	indoor use



australian  
made



7 year  
warranty

grazia&co<sup>®</sup>

## finishes & product care

---

### house leather care

protect from direct sunlight, heat and weather. dust with a clean dry cloth or use the soft brush attachment on your vacuum cleaner. remove all liquid and food spills immediately. wipe with a clean cloth dampened with proprietary brand leather cleaner suitable for a surface finish leather.

### velvet

all spills must be actioned right away- blotting the area immediately with a clean, dry absorbent cloth. never bleach, tumble dry, machine wash or iron. have velvet upholstery professionally cleaned according to the velvet suppliers' recommendations. to remove dust, vacuum regularly using low suction and soft brush attachment or using a soft lint brush.

### cotton & polyester

protect from direct sunlight. vacuum regularly using low suction and soft brush attachment. professionally clean in accordance to the fabric suppliers' instructions. treat spills and stains as soon as possible with a clean damp cloth. dry in the shade, allow to dry thoroughly before use.

### custom specified upholstery

please refer to individual suppliers for information on care and maintenance of fabrics that have been specified by a designer, as these will be outside the standard grazia&co range. most interior upholstery fabric should be regularly vacuumed and kept away from direct sunlight.

### powder coated items care

wash as required with warm soapy water using a soft clean cloth. for marine or commercial environments, we recommend regular cleaning. do not pressure wash or steam items that are powder coated. if powder coating chips due to a knock and / or rough treatment this is not covered by warranty. touch up paint can be purchased on request (depending on availability). scratches and chips should be repaired as soon as they appear.

*please visit [grazia&co website](#) for further details.*



australian  
made



no direct  
sunlight



do not dry  
clean



do not  
machine  
wash



do not iron

grazia&co®