

grazia&co melbourne
1 / 10-14 advantage road
highett, vic, 3190
phone 03 9555 5760

grazia&co sydney
12b, 32 ralph street
alexandria, nsw, 2015
phone 02 8914 0350

prince dining table and desk



australian made table with a cranked shape top of 42mm thick solid american oak or walnut with soft rounded sharknose edge detail and bean shape leg base. the desk includes a cable management system with cables discretely running inside leg.

grazia&co[®]

top - solid timber



walnut



natural oak



natural oak
dusk stain



natural oak
black stain

base - timber veneer



walnut



natural oak



natural oak
dusk stain



natural oak
black stain



technical specifications

prince dining table

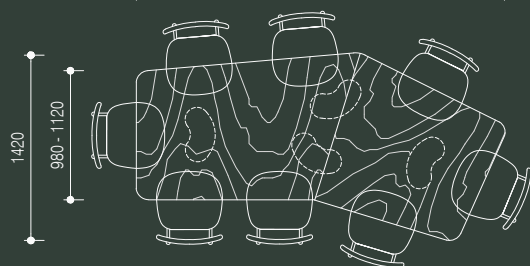
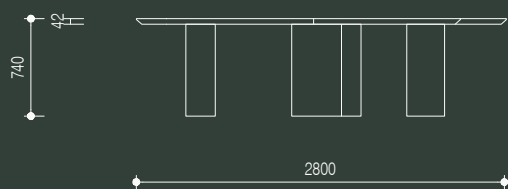
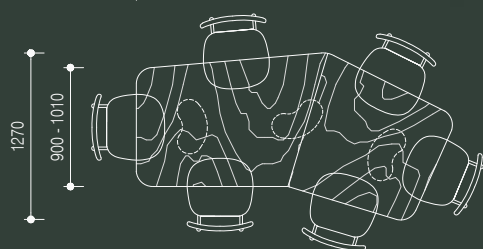
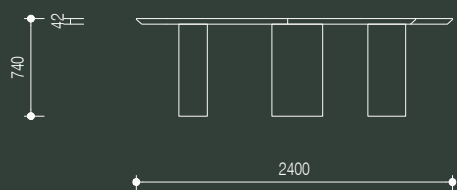

positioning of table legs is indicative only
dining chair based on scape dining chair 500l x 520d



technical specifications

prince dining table

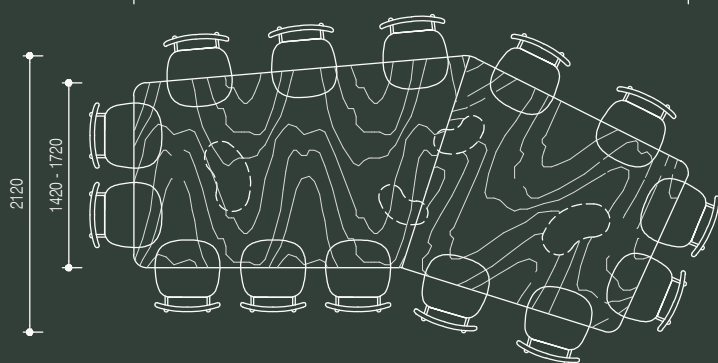
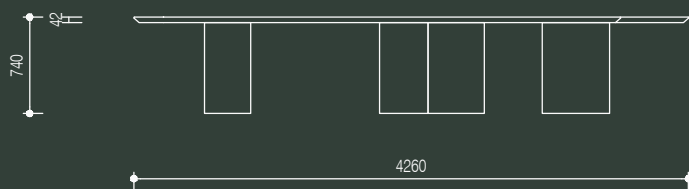
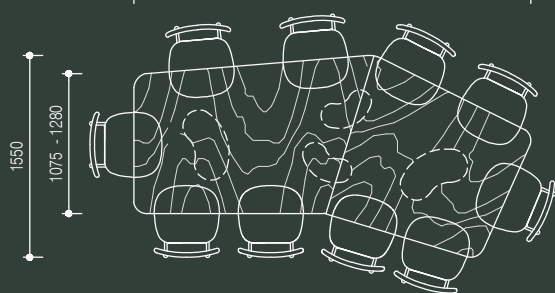
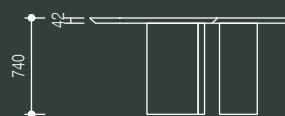
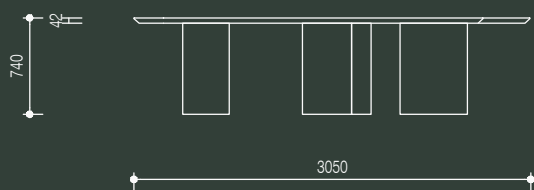

positioning of table legs is indicative only
dining chair based on scape dining chair 500l x 520d

grazia&co[®]

technical specifications

prince desk

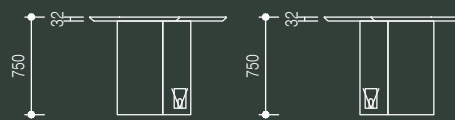
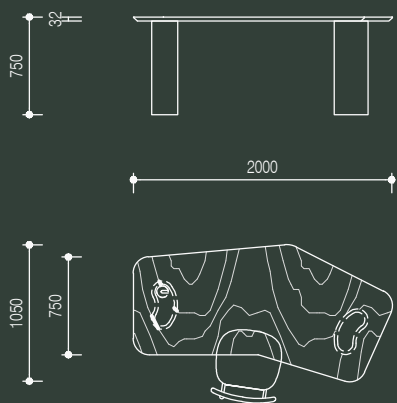

positioning of table legs is indicative only
dining chair based on scape dining chair 500l x 520d

grazia&co[®]

product specifications

designer

iva foscia for grazia&co

design registration no

201910897

year designed

2019

warranty

- i. warranty period of 2 years for the structural integrity of the furniture under 'normal use'
- ii. natural materials like solid and veneer timbers can vary in colour, natural figuration and texture. these are not considered faults.
- iii. movement, joint separation, bowing as a result of fluctuations in temperature and any damage caused by direct sunlight are not warranted.
- iv. day to day use and wear and tear that can cause scratches, expansion, colour changes, chips, burns, splits are not warranted.
- v. painted and stained timber can chip. this is not warranted and considered as wear and tear through use of the item.

all terms outlined in this document are applicable exclusively to projects and orders that are based in australia.

for warranty claims outside australia, please note that a 12 month warranty period will apply, all claims are to be taken up with the international selling agent

to view the full warranty please refer to the link below
<https://graziaandco.com.au/grazia-terms-and-conditions/>

craftmanship: manufactured in australia

materials: solid timber and veneer with stain finish

lead time: if not in stock, 12-14 weeks

suitability: indoor use



grazia&co®

solid timber and veneer

grazia&co timber furniture is finished with a clear satin lacquer inclusive of an ultraviolet light protector. this may reduce the harsh effects of direct sunlight although cannot eliminate fading and discolouration completely. therefore, we do not recommend furniture be left in direct sunlight for long periods of time. avoid placing hot crockery on furniture surfaces which in turn may burn, discolour or lift binding agents. coasters, clothes and mats can be placed between the surface and the hot object. do not position furniture over or next to heating or electrical appliances. please ensure furniture is not exposed to excessive quantities of liquids or moisture which may absorb into the timber. this may result in movements of the timber, change in form, cracking or mould. if your furniture is being used as a writing surface, grazia&co recommends blotters or pads to prevent ball point pens leaving imprints in the timber top. objects resting against or on top of furniture should have some form of padding between the timber and the object. avoid bare metal or sharp pointed edges. a small amount of natural movement of the timber is expected as it adapts to the conditions of your home, due to variations in humidity and temperature.



no direct
sunlight