

grazia&co melbourne  
1 / 10-14 advantage road  
highett, vic, 3190  
phone +61 3 9555 5760

grazia&co sydney  
12b, 32 ralph street  
alexandria, nsw, 2015  
phone +61 2 8914 0350

## harvey sofa



australian made fully upholstered sofa with feather fibre wrap seat & back cushions. straight or curve detail to arms. available in custom sizes and configurations.

grazia&co<sup>®</sup>

# upholstery specifications

## premium leather - semi aniline

semi aniline leather  
origin: europe



camel 295



tan 223



chocolate 298

## boucle

composition: 28% acrylic / 24% cotton / 20% viscose / 16% wool / 12% polyester  
origin: netherlands  
martindale cycles: 80,000



00 cream



27 terracotta

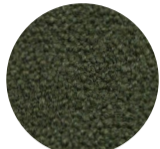

55 deep green



88 charcoal

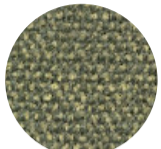

56 green  
melange



73 charcoal  
melange

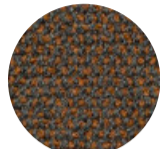

82 orange  
melange

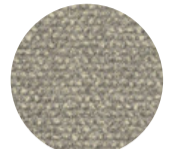

89 grey  
melange

## velvet

composition: 39% cotton / 28% alpaca / 11% polyester / 9% wool / 7% nylon / 6% viscose.  
origin: italy  
martindale cycles: 100,000



camel



porcini

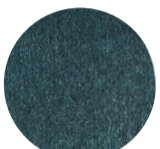

prussian

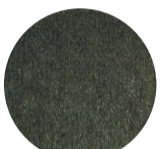

vine



olive



bronze



sienna



cacao

## linen weave

composition: 15% linen / 40% cotton / 20% viscose / 20% acrylic / 5% polyester  
origin: belgium  
matindale cycles: 45,000



putty

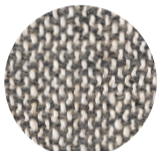

granite

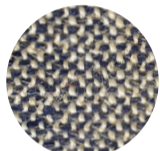

indigo



onyx

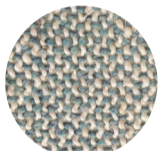

teal

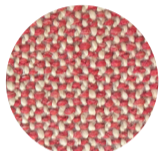

carmine



rust

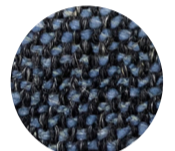

lapis

## soft textured weave

composition: 100% polyester  
origin: netherlands  
matindale cycles: 45,000



01



19



51

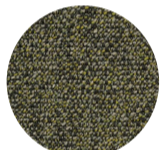

58



84



87

# frame specifications

## house powder coat



texture white



texture black



apo grey



texture suede

## premium powder coat



stone



earth



dark bronze



mangrove



deep ocean



manor red



pink sand

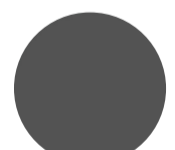

monument



deep brunswick  
green



transformer  
grey gloss



signal red  
gloss



dune

## custom

custom finishes as specified



# technical specifications

harvey curved arm sofa

1

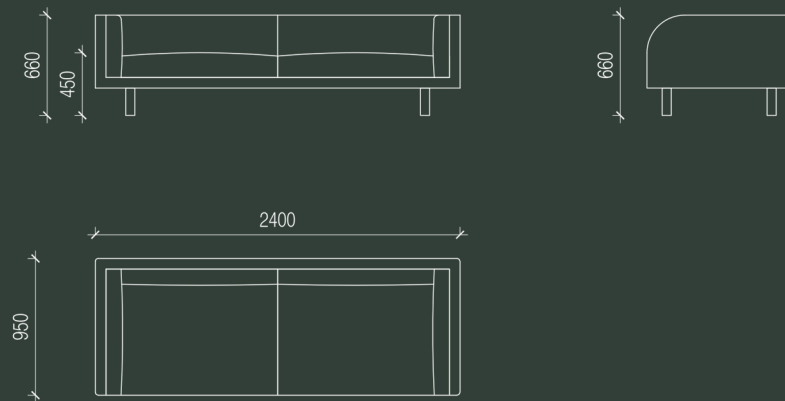

2

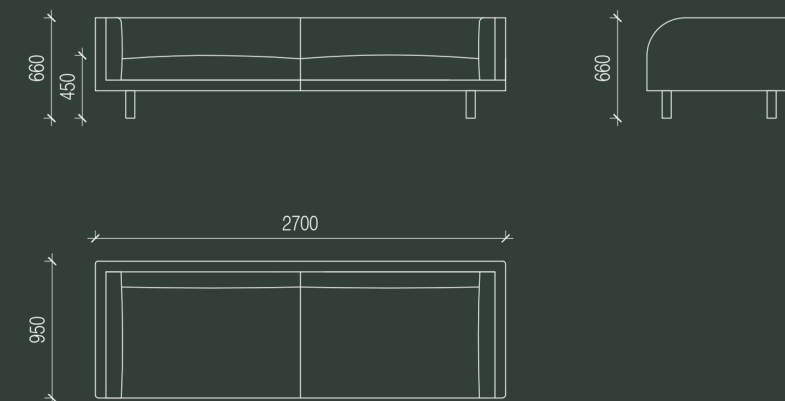

3

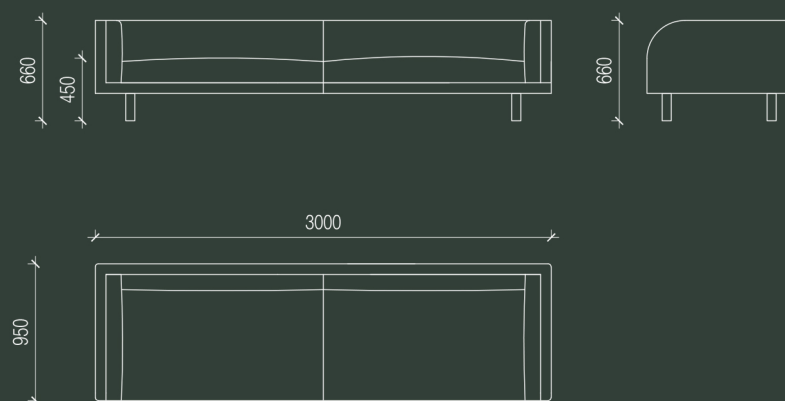

grazia&co®

# technical specifications

harvey straight arm sofa

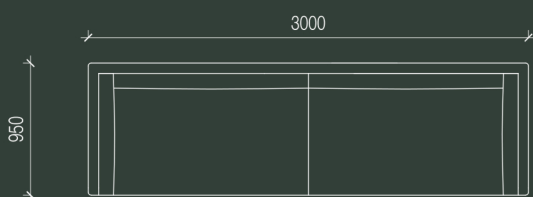
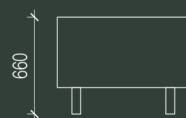
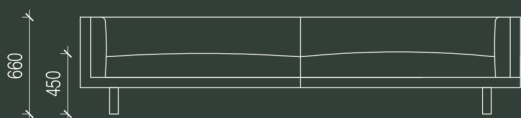
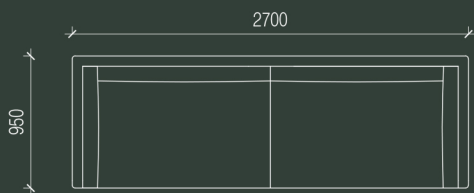
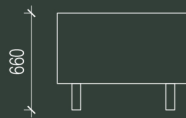
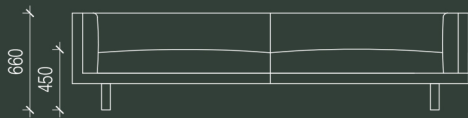
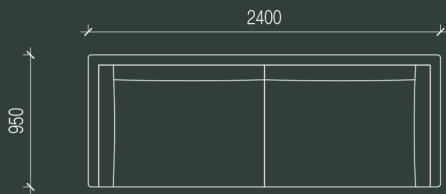
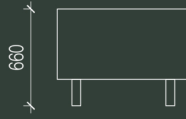
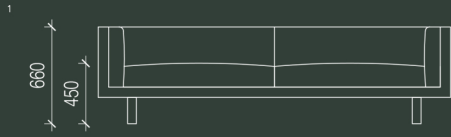

## dimensions

---

harvey sofa straight arm



harvey straight arm sofa

2400l x 950w x 450sh / 660bh

harvey sofa curved arm



harvey curved arm sofa

2400l x 950w x 450sh / 660bh

both sofas also available in sizes 2700l x 950w x 450sh / 800bh and 3000l x 950w x 450sh / 800bh

*modular and custom sizes also available*

**grazia&co**<sup>®</sup>

year released  
2015

## warranty

- i. warranty period of 7 years for the structural integrity of the furniture under 'normal use'
- ii. the warranty covers the timber and metal frames, the suspension and the foam integrity.
- iii. fabric and leather wear and tear are not warranted.
- iv. fabric and leather that has faded or broken down due to exposure to sunlight or extreme weather conditions is not warranted.
- v. care instructions and warranty claims of fabric to be addressed with the textile supplier or specifier.
- vi. it is the responsibility of the specifier and/or supplier that has selected and/or supplied a fabric or leather through 3rd party suppliers to ensure it is free of faults and fit for purpose and application.

all terms outlined in this document are applicable exclusively to projects and orders that are based in australia.

for warranty claims outside australia, please note that a 12 month warranty period will apply, all claims are to be taken up with the international selling agent

to view the full warranty please refer to the link below  
<https://graziaandco.com.au/grazia-terms-and-conditions/>

<b>craftmanship:</b>	designed and manufactured in australia
<b>materials:</b>	fully upholstered frame, feather wrapped foam and specified upholstery
<b>lead time:</b>	8-10 weeks. lead times may vary during peak periods
<b>suitability:</b>	indoor use



australian  
made



7 year  
warranty

grazia&co<sup>®</sup>

## finishes & product care

---

### house leather care

protect from direct sunlight, heat and weather. dust with a clean dry cloth or use the soft brush attachment on your vacuum cleaner. remove all liquid and food spills immediately. wipe with a clean cloth dampened with proprietary brand leather cleaner suitable for a surface finish leather.

### velvet

all spills must be actioned right away- blotting the area immediately with a clean, dry absorbent cloth. never bleach, tumble dry, machine wash or iron. have velvet upholstery professionally cleaned according to the velvet suppliers' recommendations. to remove dust, vacuum regularly using low suction and soft brush attachment or using a soft lint brush.

### cotton & polyester

protect from direct sunlight. vacuum regularly using low suction and soft brush attachment. professionally clean in accordance to the fabric suppliers' instructions. treat spills and stains as soon as possible with a clean damp cloth. dry in the shade, allow to dry thoroughly before use.

### custom specified upholstery

please refer to individual suppliers for information on care and maintenance of fabrics that have been specified by a designer, as these will be outside the standard grazia&co range. most interior upholstery fabric should be regularly vacuumed and kept away from direct sunlight.

### powder coated items care

wash as required with warm soapy water using a soft clean cloth. for marine or commercial environments, we recommend regular cleaning. do not pressure wash or steam items that are powder coated. if powder coating chips due to a knock and / or rough treatment this is not covered by warranty. touch up paint can be purchased on request (depending on availability). scratches and chips should be repaired as soon as they appear.

*please visit [grazia&co website](#) for further details.*



australian  
made



no direct  
sunlight



do not dry  
clean



do not  
machine  
wash



do not iron

grazia&co<sup>®</sup>