

Grazia & Co

1 / 10-14 Advantage Road
Highett VIC 3190
Phone +61 3 9555 5760

20 / 108 Dunning Avenue
Rosebery NSW 2018
Phone +61 2 8914 0350

Dita Stool



Made in Australia, the Dita Stool features a solid metal rod frame with a fully upholstered seat and back. Featuring a natural brass or stainless steel footrail, choose from a range of upholstery and powder coat finishes. Also available with an open back or no back.

The Dita stacking chair is also available and can be stacked up to five chairs high.

Craftsmanship:	Designed and manufactured in Australia
Materials:	Seat & backrest - ply with foam wrap, fully upholstered in specified fabric Frame - powder coated metal with natural brass or stainless steel footrail
Lead time:	10 to 12 weeks. Lead times may vary during peak periods.
Suitability:	Indoor use
Warranty:	5 years on the structural integrity of the frame.

Upholstery specifications

Vinyl – plain



Vinyl – perforated



Vinyl – leather look



Vinyl – Zone premium leather look



Vinyl – linen look



Leather – corrected grain



Coconut



Mist



Medina



Pebble



Maple Syrup



Mudcake



Black



Inky



Green Tea

Fabric – sheepskin

Composition: 100% natural wool



Black



Natural

Fabric – soft textured weave

Composition: 100% polyester



01



19

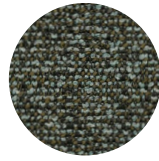

51

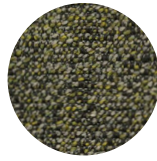

58

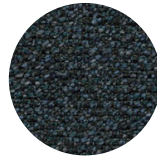

84



87

Fabric – diagonal stripe

100% post-consumer recycled polyester

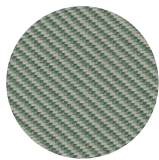

Green on Cream



Rust on Black

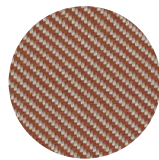

Rust on Cream



Port



Chocolate



Chocolate on Cream



Mustard

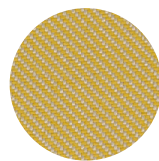

Yellow

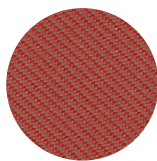

Tangerine



Charcoal

Fabric – linen weave

Composition: 15% linen / 40% cotton / 20% viscose / 20% acrylic / 5% polyester



Putty

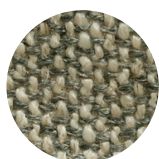

Granite

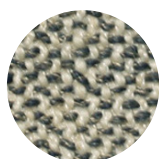

Indigo



Onyx



Teal

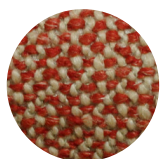

Carmine



Rust



Lapis

Fabric – boucle

Composition: 28% acrylic / 24% cotton / 20% viscose / 16% wool / 12% polyester



00 Cream



27 Terracotta



55 Deep Green



88 Charcoal

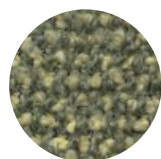

56 Green
Melange

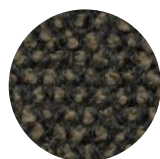

73 Charcoal
Melange

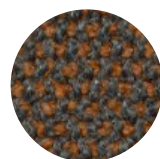

82 Orange
Melange

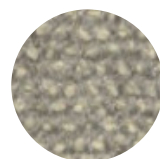

89 Grey
Melange

Fabric – velvet

Composition: 39% cotton / 28% alpaca / 11% polyester / 9% wool / 7% nylon / 6% viscose



Camel



Porcini

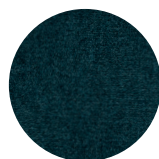

Prussian

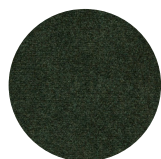

Vine

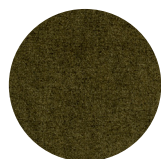

Olive



Bronze



Sienna



Cacao

Custom

Custom upholstery as specified

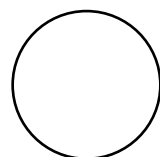

Frame specifications

House powder coat

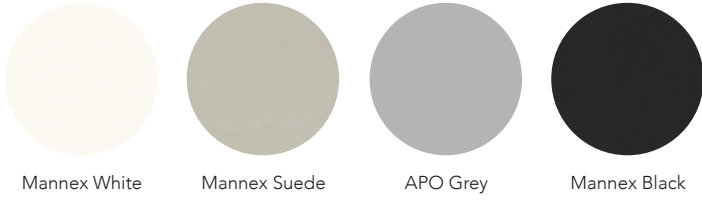

Premium powder coat



Premium finish



Base components

Footrail



Feet caps

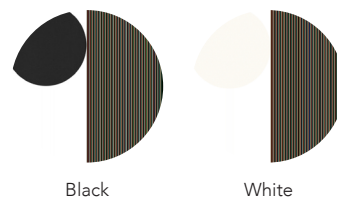

Technical Specifications

1. Junior

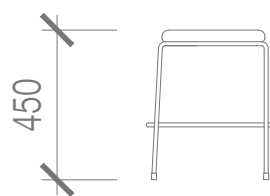
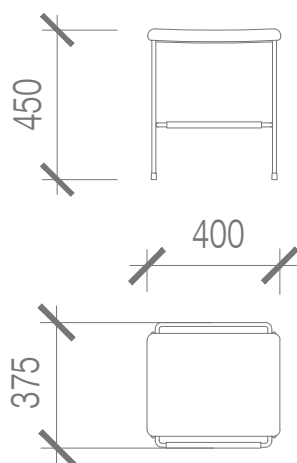

2. No back

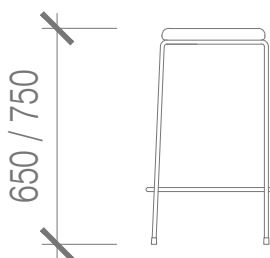
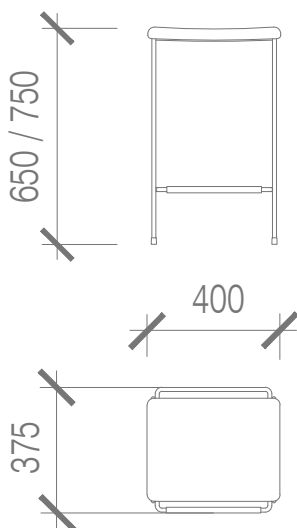

3. Open back

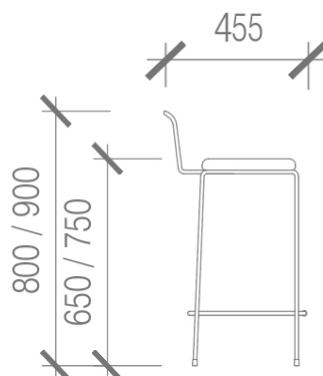
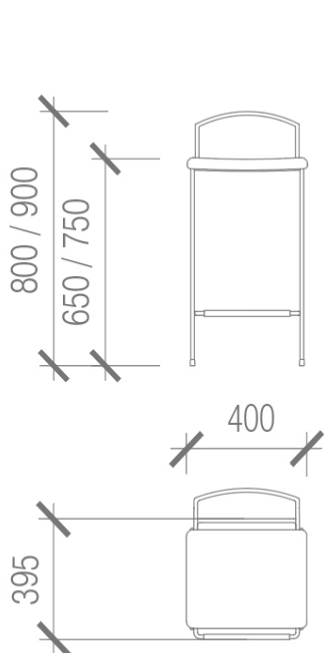

4. Upholstered back

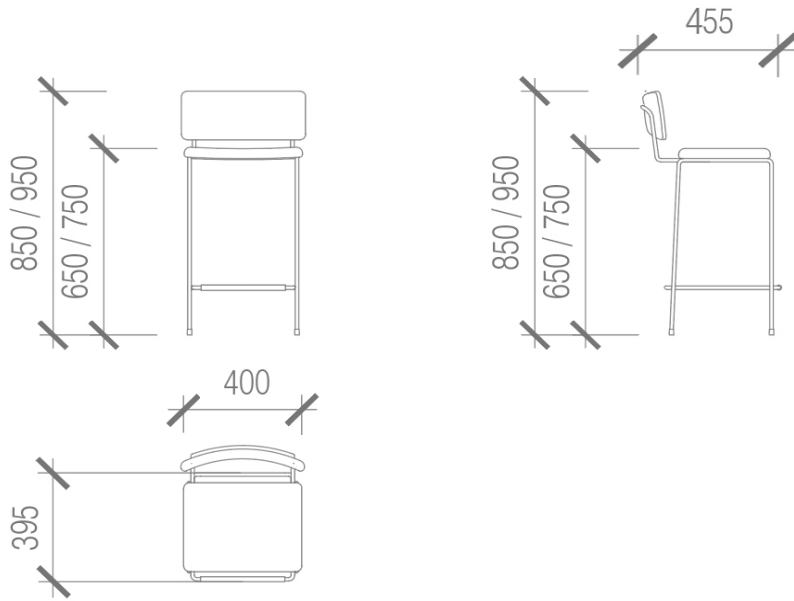

Care, Maintenance & Warranty

To ensure the longevity and integrity of your Grazia & Co product, we recommend following our care and maintenance guidelines. For detailed care instructions, warranty information and maintenance recommendations specific to your product, visit: www.graziaandco.com.au/care-maintenance-warranty



Dita stool

Design registered in 2016

Junior No. 201615714

No back: No. 201616493

Open back: No. 201616492

Upholstered back: No. 201616491